

STELLON

Lighting for construction work
Type B 170W



We are committed to provide high performance, high quality, high durability product as a reasonable price that lighting experts wanted. We aim for world best in outdoor lighting and specific object lighting



170w cylindrical LED lighting
5m ambient brightness 105lux
(Upper 2m 312lux)

Convenience (AC / Battery mode)

Scalability (Up to 10 connections)

Lighting for
construction work
Type B 170W



※This product is a picture to help you understand the exact form of the product please check the dimensions of the product.

- TYPE A : Opacity / Wheel (○)
- TYPE B : Transparency / Wheel (X)

Lighting for construction work Type B 170W

LED 170W cylindrical lighting suitable for indoor construction work lighting

■ Product Features

01. Indoor work lighting

- Reduced glare (Opaque cover)
- 5m Brightness around 100lux
- Upper ceiling 312lux

● 500Lx ● :100Lx

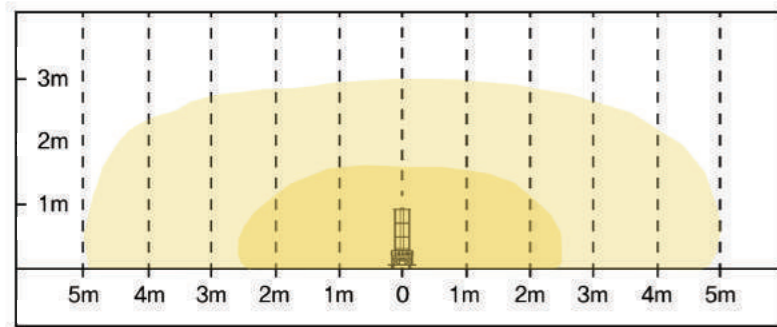

■ Specifications

-Specifications

LED	Illuminance (1M)	Beam angle	CRI	CCT	Operating temperature
Samsung	1,160(lux)	360°	OVER 80	5,700K	-20~45°C

Power Consumption		Input voltage	Wire specification	Cable length	Material	Weight	
Battery	AC	AC 160~305V (50Hz/60Hz)	2.5SQ X 3C	10m	Stainless(STS304) Aluminum(5052)	light	battery
170W	200W					17.5Kg	5.2Kg

-Battery Specifications

Enclosure Material	Kinds	Volume	Operating time	Charging time
Aluminum	Lithium	860wh	5~10hours	Around 6hours (full charge)

*Operating time may vary depending on usage environment

■ Product dimensions (1030mmX450mmX310mm)

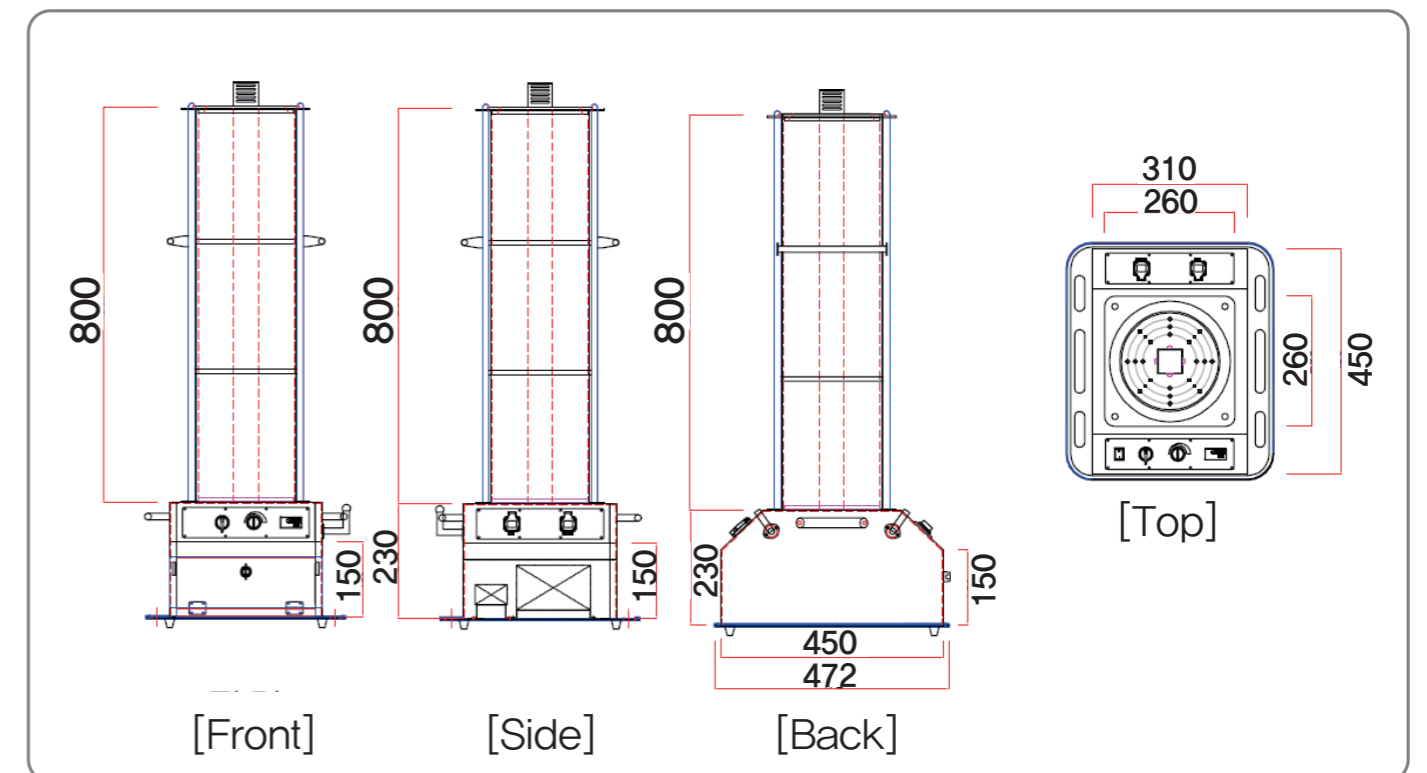

02. Connectable

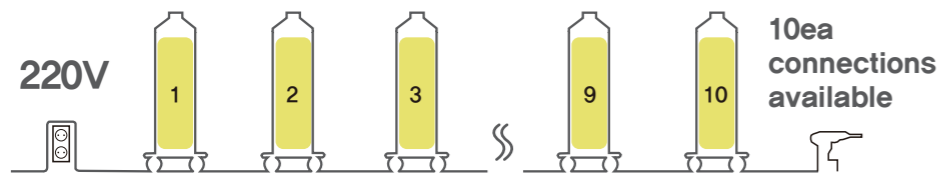

- 220V Connecting products to outlet
- Up to 10 connections

03. Portability

- AC / Battery mode
- Lithium-ion mounting

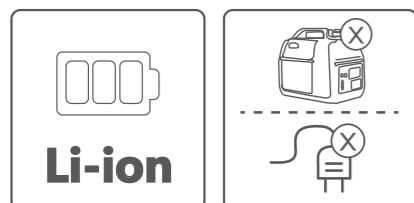

04. able to separate

- Removable top and bottom of product

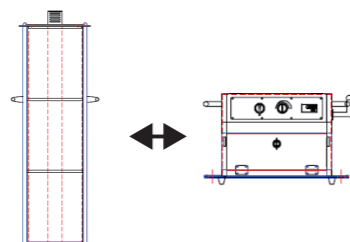

Lighting for construction work Type B 170W

■ Product composition [Construction Lighting 1ea]

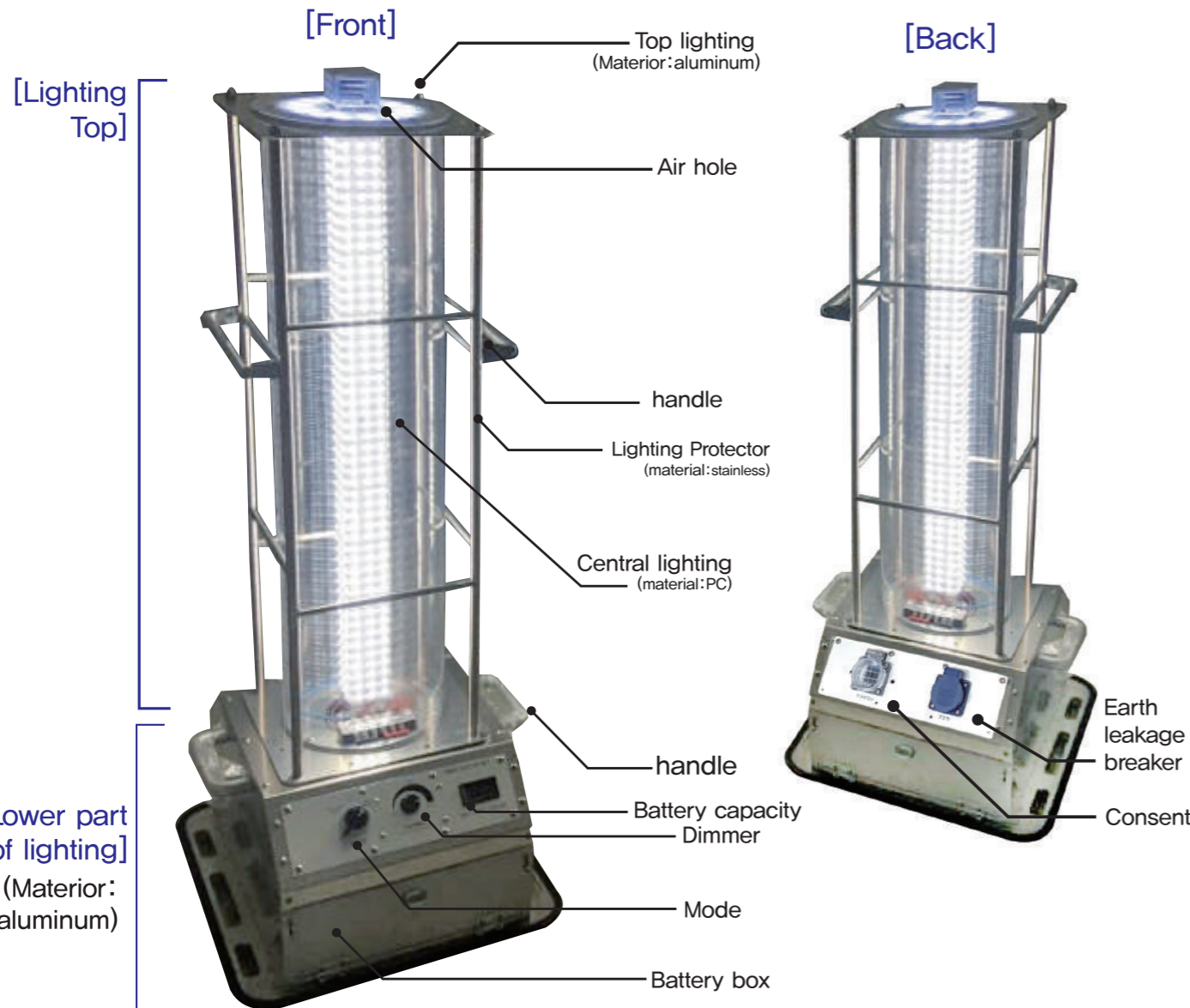

[battery 1ea]



[battery charger 1ea]



[battery bag 1ea]



■ Precautions

- ① 제품은 정격램프 전용으로 제작되었으니 **정격 전압**을 사용하십시오. (AC:220V, 50Hz/60Hz)
The product, please use the specified voltage after turning to the rated lamp dedicating.
- ② **전용 배터리를** 사용하십시오. 타 배터리 사용시 품질을 보증 할 수 없습니다.
Please use a dedicated battery. Other batteries can not guarantee quality.
- ③ 콘센트의 **허용 전류(10A)**를 사용하시기 바랍니다. Dimmer와 Battery gauge는 참조용 입니다.
Please use the allowable electric current. *참조용으로 오차가 있을수 있습니다
- ④ 배터리 교체 및 충전기 사용시 **극성에 유의**하시기 바랍니다. (잘못 연결시 미점등, 조명이 파손 될 수 있습니다.)
Please be careful of the polarity when replacing the battery and using the charger.
- ⑤ 배터리 교체시 **OFF모드**에서 교체 바랍니다.
Replace the battery in OFF mode.
- ⑥ 배터리 충전시 제품에서 **분리후 충전**하시기 바랍니다
When charging the battery, please remove it from the product and charge it.
- ⑦ **임의 분해시** 품질 보증이 되지 않습니다. 구입처로 연락 부탁드립니다.
C/S is not guaranteed when disassembled, please ask to store which your bought

■ Application

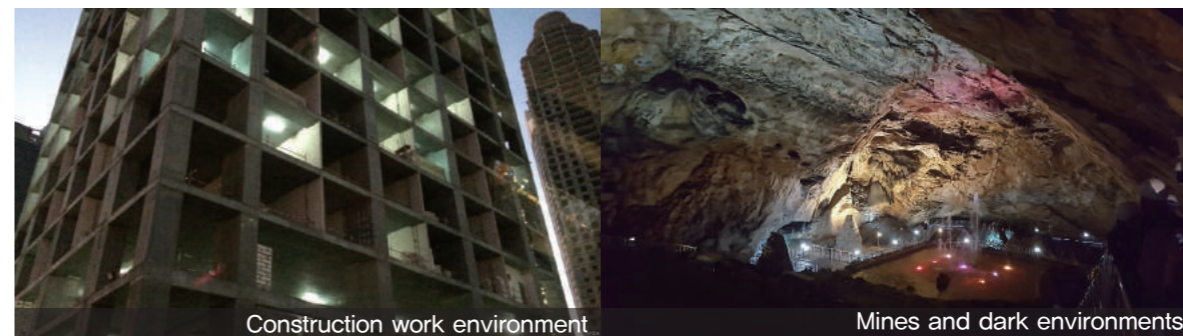

■ Product comparison

	TYPE A	TYPE B
Wheel	O	X
Central light cover	Opacity	Transparency

STELLON Brightly anywhere

어디서나 우리에게 빛을
밝혀주는 마음으로...

e.GM Tech



Professional manufacturer of LED
special lighting and luminaire

Date of
establishment 2010년 12월 29일

CEO KIM SEOUNG HUN

Address 1gongdanro 86-21 Gumi-Si
Gyungsoangbuk-Do KOREA

Homepage www.stellon.kr

TEL 054-473-9420

LED & 조명